

IN122a, IN124a, IN126a

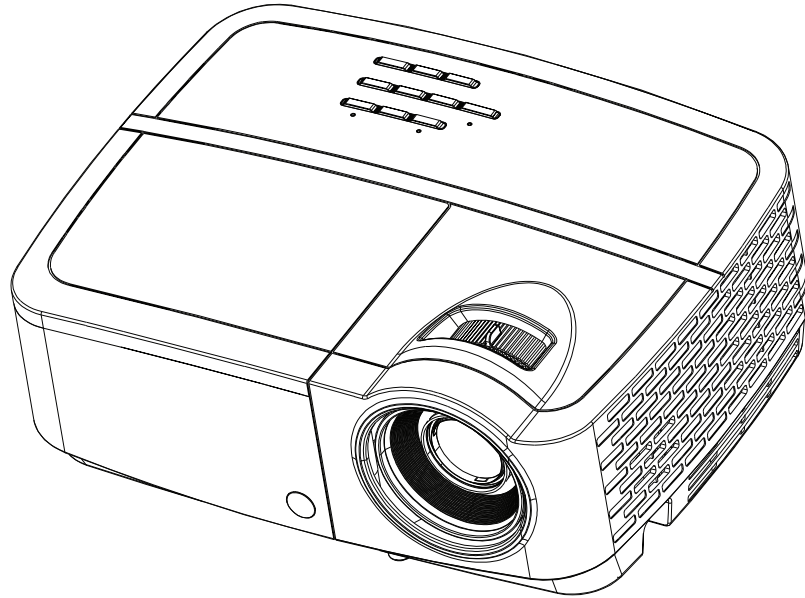

PY239-A000-01
DISPERINDAG No. 0287/1.824,51/09.03
Regulatory models: IN122a, IN124a, IN126a

InFocus
The New Way to Collaborate

Declaration of Conformity

Manufacturer: InFocus Corporation, 13190 SW 68th Parkway, Suite 200, Portland, Oregon 97223-8368 USA

We declare under our sole responsibility that this projector conforms to the following directives and norms:

ErP Directive 2009/125/EC

EMC Directive 2004/108/EC

EMC: EN 55022, EN 55024, EN 61000-3-2, EN 61000-3-3

Low Voltage Directive 2006/95/EC

Safety: IEC 60950-1: 2005;EN 60950-1:2006 +A11:2009

Trademarks

Apple, Macintosh, and PowerBook are trademarks or registered trademarks of Apple Computer, Inc. IBM is a trademark or registered trademark of International Business Machines, Inc. Microsoft, PowerPoint, and Windows are trademarks or registered trademarks of Microsoft Corporation. Adobe and Acrobat are trademarks or registered trademarks of Adobe Systems Incorporated. DLP®, DLP Link and the DLP logo are registered trademarks of Texas Instruments and BrilliantColor™ is a trademark of Texas Instruments. InFocus, In Focus, and INFOCUS (stylized) are either registered trademarks or trademarks of InFocus Corporation in the United States and other countries.



NOTE: This product is covered electrical and electronic equipment under the European Union's Waste from Electrical and Electronic Equipment ("WEEE") Directive (2002/96/EC). The WEEE Directive requires that covered equipment be collected and managed separately from typical household waste in all EU member states. Please follow the guidance of your local environmental authority or ask the shop where you purchased the product for collection or recycling options.

FCC Warning

This device complies with part 15 of the FCC Rules. Operation is subject to the following two conditions: (1) This device may not cause harmful interference, and (2) this device must accept any interference received, including interference that may cause undesired operation.

Note: This equipment has been tested and found to comply with the limits for a Class B digital device, pursuant to part 15 of the FCC Rules. These limits are designed to provide reasonable protection against harmful interference in a residential installation. This equipment generates, uses and can radiate radio frequency energy and, if not installed and used in accordance with the instructions, may cause harmful interference to radio communications. However, there is no guarantee that interference will not occur in a particular installation. If this equipment does cause harmful interference to radio or television reception, which can be determined by turning the equipment off and on, the user is encouraged to try to correct the interference by one or more of the following measures:

--Reorient or relocate the receiving antenna.

--Increase the separation between the equipment and receiver.

--Connect the equipment into an outlet on a circuit different from that to which the receiver is connected.

--Consult the dealer or an experienced radio/TV technician for help.

Changes or modifications not expressly approved by InFocus Corporation may void authority to operate the equipment.

Canada

This Class B digital apparatus complies with Canadian ICES-003. Cet appareil numérique de la classe B est conforme à la norme NMB-003 du Canada.

Agency Approvals

cMETus

Other specific Country Approvals may apply. Please see product certification label.

This document applies to regulatory model IN122a/IN124a/IN126a

Input ratings: 100-240Vac, 3.2A, 50-60Hz

InFocus reserves the right to alter product offerings and specifications at any time without notice.

Table of Contents

Introduction	4	Displaying pictures with a USB storage device	37
Positioning the projector	6	Maintenance	45
Connecting a computer source	7	Cleaning the lens	45
VGA connection	7	Using the security lock	45
USB connection	7	Replacing the projection lamp	46
HDMI connection	7		
Connecting power	7		
Optional computer connections	7		
Displaying an image	8		
Adjusting the image	9		
Connecting a video device	10		
Video device connections	10		
Composite video connection	10		
VGA connection	10		
Component video connection	10		
S-video connection	10		
Audio	10		
Shutting down the projector	11		
Troubleshooting your setup	11		
Using the remote control	19		
Using the audio	20		
Using the keypad buttons	21		
Optimizing computer images	22		
Presentation features	22		
Optimizing video images	23		
Customizing the projector	23		
Using the menus	24		
Basic Menu	25		
Advanced Menu	26		
Controlling the projector through a WLAN environment	29		
Web controlling the projector	30		
Displaying images through EZ Display	31		
Projecting from Smartphones/Tablets	32		
EZ USB Display	36		

Important Operating Considerations for Safety

- Refer to this guide for proper startup and shutdown procedures.
- Follow all warnings and cautions in this manual and on the projector.
- Place the projector in a horizontal position no greater than 15 degrees off axis.
- Locate the projector at least 4' (1.2m) away from any heating or cooling vents.
- Do not block ventilation openings. Locate the projector in a well-ventilated area without obstructions to intake or exhaust vents. Do not place the projector on a tablecloth or other soft covering that may block the vents.
- Do not place the projector in direct sunlight, humid, greasy or dusty places or in places where the projector may come into contact with smoke or steam.
- Do not touch or block the projector lens with any objects as this can damage the projector lens. Scratches, gouges and other lens damage are not covered by the product warranty.
- Do not look directly into the lens while the projector is being used.
- Do not drop the projector.
- Do not spill liquid on the projector. Spilled liquid may damage the projector.
- Use the power cord provided. Connect the power cord to a receptacle with a protective safety (earth) ground terminal. A surge-protected power strip is recommended.
- Do not overload wall outlets.
- When disconnecting the power cord, hold the plug, not the cord.
- Wash hands after handling the cables supplied with this product.
- The projector remote control uses batteries. Make sure the batteries' polarity (+/-) is aligned correctly. Dispose of used batteries in accordance with local disposal laws.
- Use an InFocus approved ceiling mount kit for proper fitting, ventilation and installation. The warranty does not cover any damage caused by use of non-approved ceiling mount kits or by installing in an improper location.
- When the projector is ceiling mounted, wear protective eyewear to prevent eye injury before opening lamp door.

- Refer all service to qualified service personnel. Servicing your own projector can be dangerous to you and will void the warranty.
- Only use replacement parts specified by InFocus. Unauthorized substitutions may result in fire, electrical shock, or injury, and may void the warranty.
- Only genuine InFocus lamps are tested for use in this projector. Use of non InFocus lamps may cause electrical shock and fire, and may void the projector warranty.
- Hg – Lamp contains mercury. Manage in accordance with local disposal laws. See www.lamprecycle.org.
- The projector uses a high-pressure mercury glass lamp. The lamp may fail prematurely, or it may rupture with a popping sound if jolted, scratched, or handled while hot. The risk of lamp failure or rupture also increases as the lamp age increases; please replace the lamp when you see the "Replace Lamp" message.
- In the unlikely event of a lamp rupture, particles may exit through the projector vents. Please keep people, food, and drinks at least 3' (1m) away from all projector vents. For ceiling applications, keep people, food and drinks out of the "keep out" area under and around the projector, as indicated by the illustration.

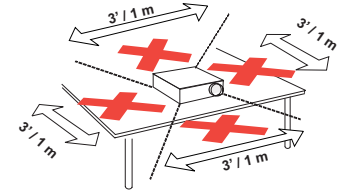
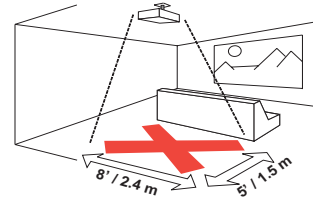

Follow these instructions to help ensure image quality and lamp life over the life of the projector. Failure to follow these instructions may affect the warranty. For complete details of the warranty, see the Warranty/Safety booklet.

Introduction

Your new digital projector is simple to connect, easy to use, and straightforward to maintain. It is a versatile projector that is flexible enough for business presentations and home video viewing too. IN122a has native SVGA 800 x 600 resolution, IN124a has native XGA 1024 x 768 resolution, and IN126a has native WXGA 1280 x 800 resolution.

Product specifications

To read the latest specifications on your multimedia projector, be sure to visit our website at www.infocus.com, as specifications are subject to change.

Accessories

The standard accessories that came with your projector are listed in the included Quick Start Guide. Optional accessories can be found on our website at www.infocus.com/support or at your retailer or dealer.

Online registration

Register your projector on our website at www.infocus.com/register to activate your warranty and receive product updates, announcements, and registration incentives.

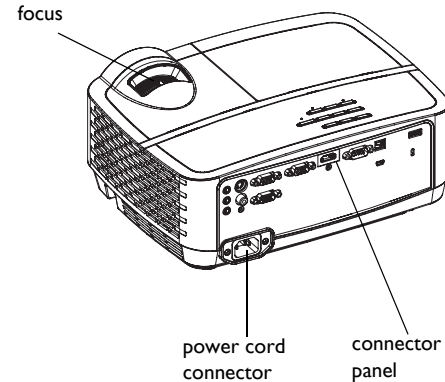
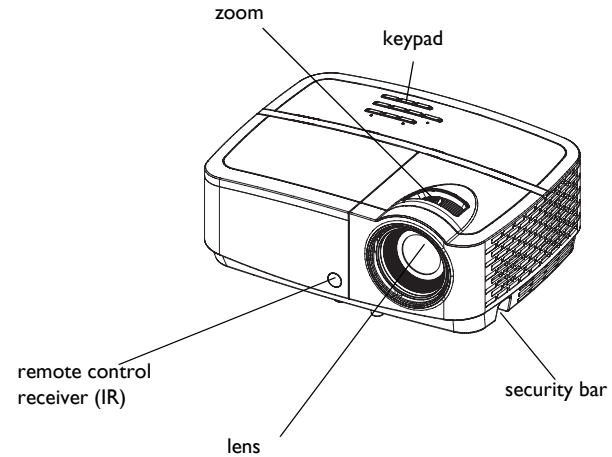

Connector panel

The projector provides both computer and video connection options, including:

- VGA computer (2)
- Composite video
- HDMI
- S-video
- USB B connector (for projector firmware upgrades, mouse control and Screen Saver Preventer)
- USB Mini B (for Display over USB, loading internal memory and EZ media firmware upgrade)
- USB A (View photos, movies, documents and listen to audio from USB drive, display wirelessly with optional WiFi adapter)
- Monitor out, for VGA pass through to an external monitor.
- Audio inputs for video and computer.
- Audio output to external speakers.
- RS-232 serial control. Command control codes are on our support website at www.infocus.com/support.

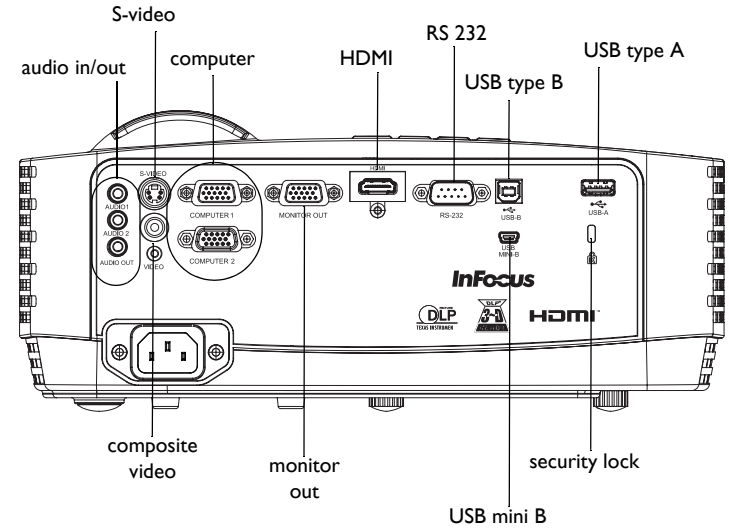

Positioning the projector

To determine where to position the projector, consider the size and shape of your screen, the location of your power outlets, and the distance between the projector and the rest of your equipment. Here are some general guidelines:

- Position the projector on a flat surface at a right angle to the screen. IN122a and IN124a must be at least 45.3" (1.2m) from the projection screen, and IN126a must be at least 55.4" (1.4m) from the projection screen.
- If you are installing the projector on the ceiling, we strongly recommend using InFocus approved ceiling mounts for proper fitting, ventilation and installation. Refer to the installation guide that comes with the InFocus Ceiling Mount Kit (p/n PRJ-MNT-UNIV) for more information. The warranty does not cover any damage caused by use of non-approved ceiling mount kits or by installing in an improper location. To turn the image upside down, see "Ceiling mount" on page 27. We recommend using an InFocus authorized ceiling mount.
- Position the projector the desired distance from the screen. The distance from the lens of the projector to the screen and the video format determine the size of the projected image.

Model	Minimum Distance to Screen	Offset	Offset for 60in. Image
IN122a	45.3"/1.2m	15%+-5%	9"/22.9cm
IN124a	45.3"/1.2m	15%+-5%	9"/22.9cm
IN126a	55.4"/1.4m	13%+-5%	7.8"/19.8cm

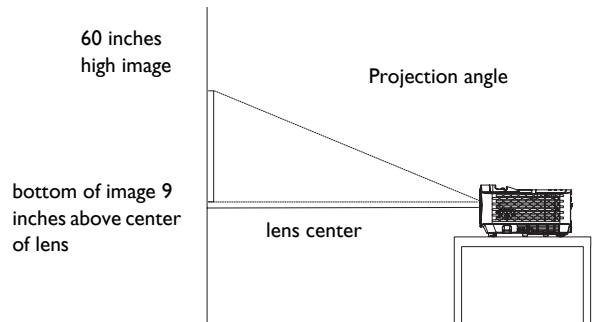

Table 1: IN122a (SVGA)/IN124a (XGA) Screen size
Throw Ratio = 1.9 to 2.2

Diagonal Screen Size (inches/m)	Size of the Projected Image Width (inches/m)	Distance to screen	
		Minimum distance (inches/m)	Maximum distance (inches/m)
40"/1.0m	32"/0.8m	62"/1.6m	69"/1.7m
60"/1.5m	48"/1.2m	94"/2.4m	103"/2.6m
80"/2.0m	64"/1.6m	125"/3.2m	137"/3.5m
100"/2.5m	80"/2.0m	156"/4.0m	172"/4.4m
150"/3.8m	120"/3.0m	234"/5.9m	257"/6.5m

Table 2: IN126a (WXGA) Screen size
Throw Ratio = 1.5 to 1.8

Diagonal Screen Size (inches/m)	Size of the Projected Image Width (inches/m)	Distance to screen	
		Minimum distance (inches/m)	Maximum distance (inches/m)
45"/1.1m	38"/1.0m	55.4"/1.4m	69.3"/1.8m
60"/1.5m	51"/1.3m	74.5"/1.9m	92.9"/2.4m
80"/2.0m	68"/1.7m	100.0"/2.5m	124.4"/3.2m
100"/2.5m	85"/2.2m	125.5"/3.2m	155.8"/4.0m
150"/3.8m	128"/3.2m	189.2"/4.8m	234.6"/6.0m

Connecting a computer source

VGA connection

Connect one end of the provided computer cable to the **Computer 1/Computer 2** connector on the projector and the other to the VGA connector on your computer. If you are using a desktop computer, you will need to disconnect the monitor cable from the computer's video port first.

connect VGA cable

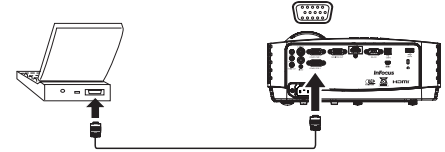

USB connection

Connect one end of the USB cable to the USB MINI-B connector on the projector and the other to the USB connector on your computer. See page 36 for details.

connect USB cable

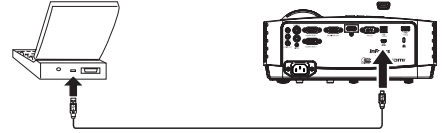

HDMI connection

HDMI is a standard, uncompressed, all-digital audio/video interface. HDMI provides an interface between sources, such as set-top boxes, DVD players, and receivers and your projector. Plug an HDMI cable into the video-out connector on the video device and into the HDMI connector on the projector.

connect HDMI

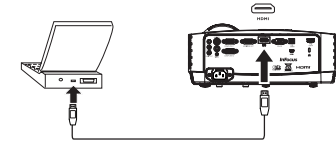

Connecting power

Connect the black power cord to the **Power** connector on the rear of the projector and to your electrical outlet. If the Power Saving Mode feature is off, the Power LED on the Status Indicator Panel (page 11) blinks blue. If the Power Saving Mode feature is on, the Power LED is steady blue. By default, this feature is off. You can change the setting, see page 28. **NOTE:** Always use the power cord that shipped with the projector.

connect power

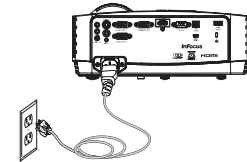

Optional computer connections

To get sound from the projector, connect an audio cable (optional cable, not included) to your computer and to the **Audio 1/Audio 2** connector on the projector. You may also need an adapter.

connect audio cable

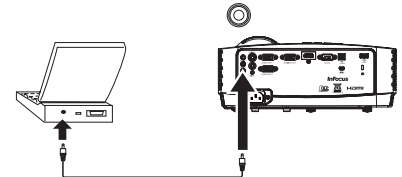

Displaying an image

Press the **Power** button.

The Power LED lights blue, and the fans start to run. When the lamp comes on, the start up screen displays. It can take up to a minute for the image to achieve full brightness. Note: When the feature, AC Power On, is enabled, the projector automatically turns on when power is connected. This allows control of ceiling mounted projectors with a wall power switch.

No start up screen? Get help on page 12.

Turn on your computer or video device.

The image should appear on the projection screen. If it doesn't, press the **Source** button on the projector's keypad or remote.

If you are using a VGA cable to connect your computer to the projector:

If using a laptop, make sure its external video port is active.

Many laptops do not automatically turn on their external video port when a projector is connected. Usually a key combination like FN + F8 or CRT/LCD key turns the external display on and off. Locate a function key labeled CRT/LCD or a function key with a monitor symbol. Press FN and the labeled function key simultaneously.

Refer to your laptop's documentation for more information about your laptop's key combination.

No laptop image? Try pressing the **Auto Image** button on the remote. Get help on page 12.

press Power button

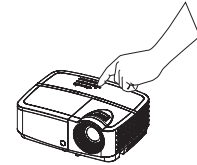

turn on computer or video device

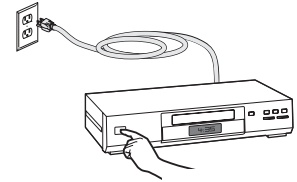

activate laptop's external port



monitor key or
LCD/CRT key

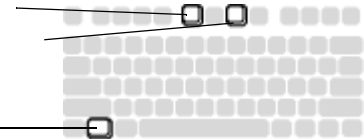

FN key

Adjusting the image

If necessary, adjust the height of the projector by rotating the elevator foot to extend the foot.

If necessary, rotate the leveling foot located at the rear of the projector.



Avoid placing your hands near the hot exhaust vent at the front of the projector.

Position the projector the desired distance from the screen at a 90 degree angle to the screen.

See page 6 for a table listing screen sizes and distances.

Adjust the zoom or focus.

If the image is not square, first make sure that the projector is perpendicular to the screen. If the image is larger or smaller on the top or bottom edge of the screen, press the top

Keystone button  to reduce the upper part of the image, and press the bottom **Keystone** button  to reduce the lower part.

If the left or right side of the screen is larger or smaller the other, you can turn the projector to the left or to the right a few degrees to square the image.

Adjust the Contrast or Brightness in the Basic Menu. See page 25 for help with these menu adjustments.

adjust height

elevator
foot

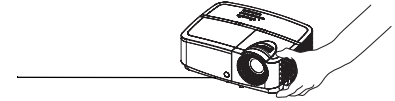

adjust distance

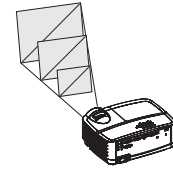

adjust zoom and focus

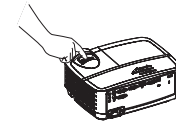

adjust keystone

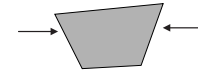
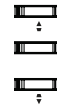

adjust Basic Menu



Connecting a video device

You can connect video devices such as VCRs, DVD players, camcorders, digital cameras, video game consoles, HDTV receivers, and TV tuners to the projector. You can connect the audio directly to the projector to get sound from the built-in speaker, or you can bypass the projector's audio system and connect the audio directly from your source to a stereo or home theater system.

You can connect the projector to most video devices that can output video. You cannot directly connect the coaxial cable that enters your house from a cable or satellite company, the signal must pass through a tuner first. Examples of tuners are digital cable boxes, VCRs, digital video recorders, and satellite TV boxes. Basically, any device that can change channels is considered a tuner.

Before connecting your projector, you should decide which aspect ratio you want to use. The projector's Aspect Ratio setting is accessed through the Resize button on the remote or through the projector's Basic Menu. See page 25 for more information.

Video device connections

No video cables are provided with the projector. You can order cables from InFocus or provide your own.

HDMI connection

HDMI is a standard, uncompressed, all-digital audio/video interface. HDMI provides an interface between sources, such as set-top boxes, DVD players, and receivers and your projector. Plug an HDMI cable into the video-out connector on the video device and into the HDMI connector on the projector.

Composite video connection

Plug the composite video cable's yellow connector into the video-out connector on the video device. Plug the other yellow connector into the yellow **Video** connector on the projector.

VGA connection

If your video device has a 15-pin VGA output, plug one end of the included computer cable into the VGA connector on your video source. This connector may be labeled "To Monitor" on the video source. Plug the computer cable into either the **Computer 1** or **Computer 2** connector on the projector.

Component video connection

If your HD video device has component connectors, an optional Component to VGA adapter can be used. Plug the component cable into the video device. Plug the other end of the component cable into the adapter and plug the adapter into the **Computer 1** or **Computer 2** connector.

S-video connection

Plug the S-video cable's connector into the video-out connector on the video device. Plug the other connector into the **S-Video** connector on the projector.

Audio

For audio, connect a 3.5mm stereo cable to the **Audio 1/Audio 2** connector on the projector and to your source. If your source uses RCA audio connectors, a Y-cable or adapter may be used. (Note: A separate audio connection is not required for HDMI source inputs.)

Shutting down the projector

Auto Off Time

The projector also has an Auto Off Time feature that automatically turns the projector off after no active sources are detected and no user interaction with the projector is performed for 30 minutes. By default, this feature is off. You can change the length of time, see page 29.

Turning off the projector

To turn the projector off, press the **Power** button on the remote or keypad. The lamp turns off and the Power LED blinks blue for 30 seconds while the fans continue to run to cool the lamp. If the Power Saving Mode feature is on and when the lamp has cooled, the LED lights blue and the fans stop. If the Power Saving Mode feature is off and when the lamp has cooled, the LED blinks blue and the fans stop. Unplug the power cable to completely power off the projector.

Troubleshooting your setup

If your image appears correctly on the screen, skip to the next section. If it does not, troubleshoot the setup.

The Status Indicator Lights on top of the projector indicates the state of the projector and can help you troubleshoot.



Table 3: Indicator Lights

Status Indicator Light	Meaning
POWER: Solid Blue TEMP: Off LAMP: Off	<ol style="list-style-type: none">1. If the Power Saving Mode feature is on, the projector is plugged in.2. The projector is on and initialized.3. The projector is in normal operation.
POWER: Blinking Blue TEMP: Off LAMP: Off	<ol style="list-style-type: none">1. If the Power Saving Mode is off, the projector is plugged in.2. The projector is powering down and the fans are cooling the projector.
POWER: Blinking blue TEMP: Blinking red LAMP: Blinking red	The projector fan(s) are not operating correctly and the projector has been shut down.
POWER: Solid blue TEMP: Blinking red LAMP: Blinking red	The lamp failed to ignite. Contact Technical Support if the problem persists. Visit www.infocus.com/support to contact service.
POWER: Solid blue TEMP: Blinking red LAMP: Blinking red	The lamp has reached its end of life and must be replaced. The lamp will continue to operate until it fails. Contact Technical Support. Repair may be needed.
POWER: Solid blue TEMP: Blinking blue LAMP: Blinking blue	<ol style="list-style-type: none">1. The projector is overheating and the lamp will be shut off. The fans will continue to run.2. The projector will not turn back on until the cooling process is complete.

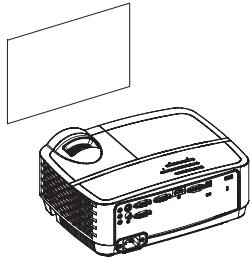
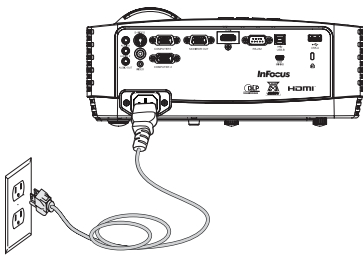
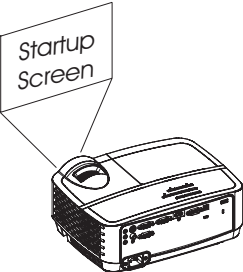
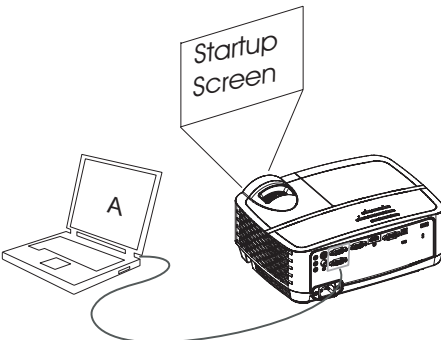
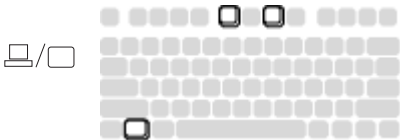
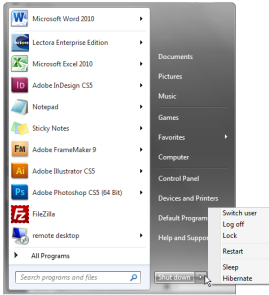
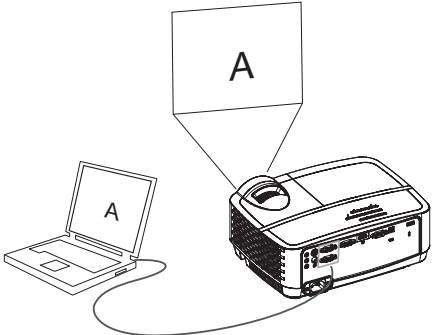
Problem	Solution	Result
<p data-bbox="48 114 243 143">No start up screen</p> 	<p data-bbox="663 114 1015 172">Plug power cord into the projector press the Power button</p> 	<p data-bbox="1183 114 1336 143">Correct image</p> 
<p data-bbox="48 487 338 516">Only start up screen appears</p> 	<p data-bbox="663 482 963 533">Press the SOURCE button. activate laptop's external port</p>  <p data-bbox="677 792 833 820">Restart laptop</p> 	<p data-bbox="1183 487 1458 516">Computer image projected</p> 

Problem

No computer image, just the words “Signal out of range”

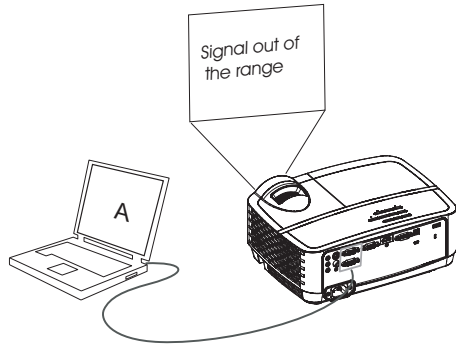

Solution

Press the Auto Image button on remote
Adjust computer refresh rate (Windows 7: Control Panel > Display > Screen Resolution > Advanced Settings > Adapter tab). Varies per operating system.

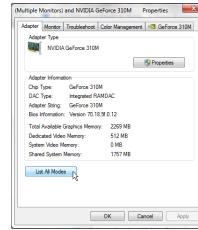

You may also need to set a different resolution on your computer, as shown in the following problem, “image fuzzy or cropped”

Result

Computer image projected

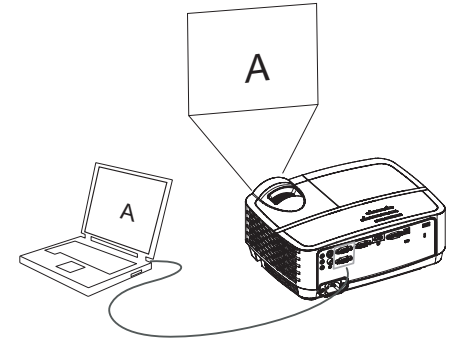

Only my laptop's background appears, not the Desktop icons

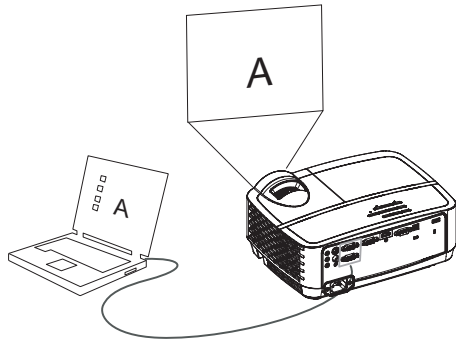

Change the Multiple Display setting to "Duplicate these displays" (Windows 7: Control Panel > Display > Screen Resolution). Varies per operating system.

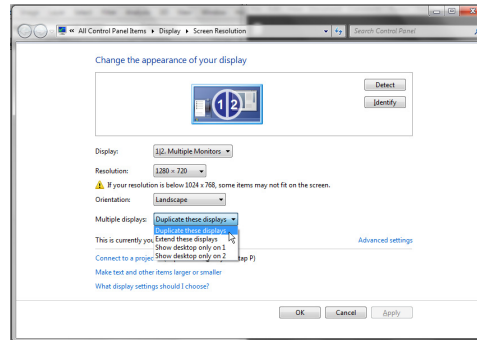

Background and Desktop projected

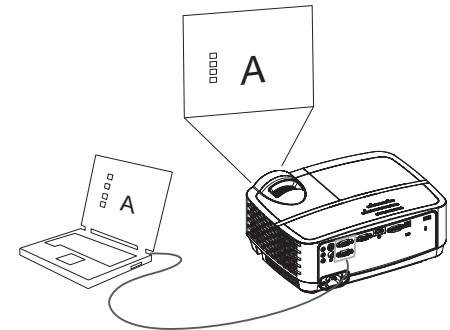

Problem

Image fuzzy or cropped

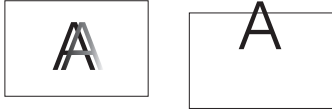
**Solution**

Change the computer's "Resolution" setting to match the projector's resolution (Windows 7: Control Panel > Display > Screen Resolution). Varies per operating system.

**Result**

Image clear and not cropped



Image not centered on screen

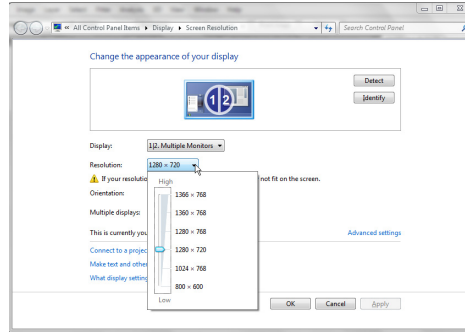
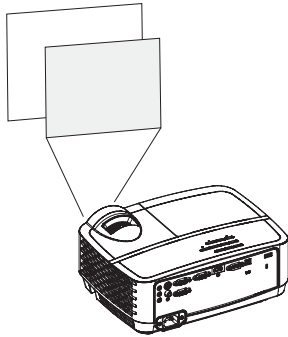

Move projector, adjust height

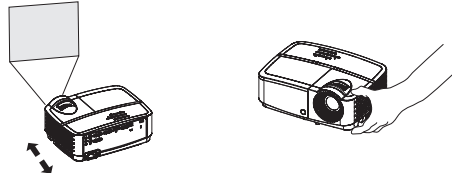



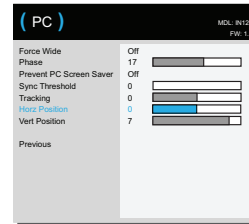



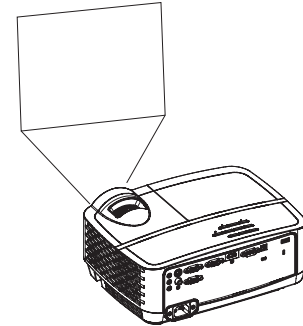

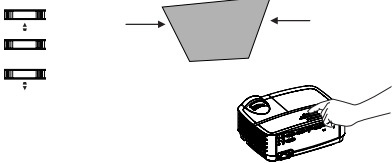

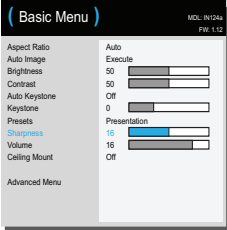

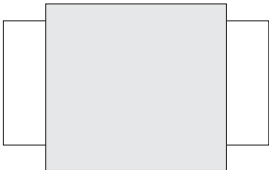
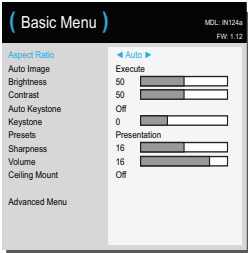
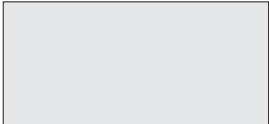
Adjust horizontal or vertical position in Advanced Menu > Image > PC... menu

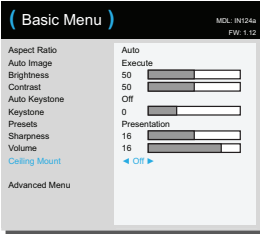

Correct image

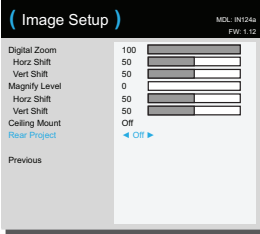

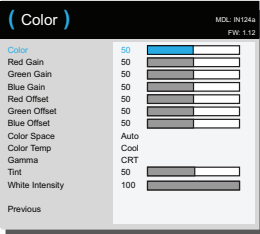
Problem	Solution	Result
<p data-bbox="48 96 222 119">Image not square</p> 	<p data-bbox="604 96 874 119">Adjust Keystone on keypad</p> 	<p data-bbox="1182 96 1314 119">Square image</p> 
<p data-bbox="48 357 210 379">Image not sharp</p> 	<p data-bbox="604 351 951 374">Adjust Sharpness in the Basic Menu</p> 	<p data-bbox="1182 362 1326 385">Correct image</p> 
<p data-bbox="48 655 413 678">Image does not fit 4:3 or 16:9 screen</p> 	<p data-bbox="604 655 1104 707">Change aspect ratio to 4:3 or 16:9 in Basic Menu > Aspect Ratio menu</p> 	<p data-bbox="1182 649 1326 672">Correct image</p> 

Problem	Solution	Result
<p>Image upside down</p> 	<p>Turn off Ceiling Mount in Basic menu</p> 	<p>Correct image</p> 
<p>Image reversed left to right</p> 	<p>Turn off Rear Project in Advanced Menu > Setup > Image Setup... menu</p> 	<p>Correct image</p> 
<p>Projected colors don't match source</p> 	<p>Adjust the items in the Advanced Menu > Image > Color... menu</p> 	<p>Correct image</p> 

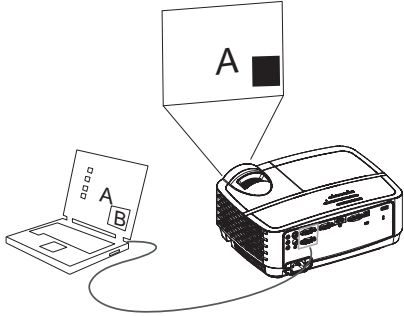
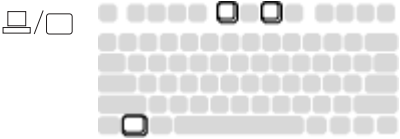
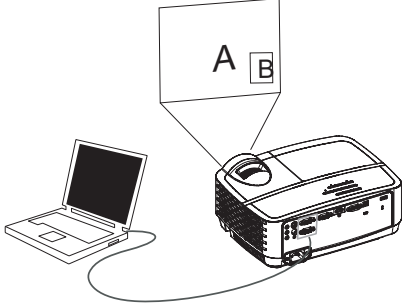
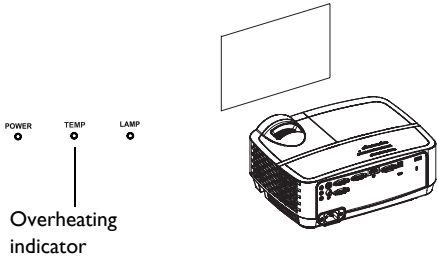
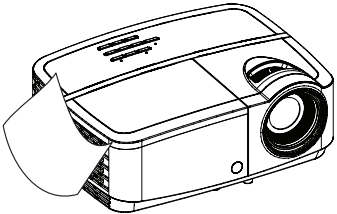
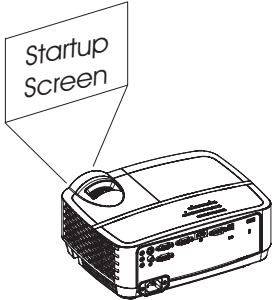
Problem	Solution	Result
<p>The video embedded in my PowerPoint presentation does not play on the screen</p> 	<p>Turn off the internal LCD display on your laptop</p> 	<p>Embedded video plays correctly</p> 
<p>Lamp won't turn on, the projector is overheating</p> 	<p>Make sure vents aren't blocked, turn off the projector and allow it to cool for one minute</p> 	<p>Lamp turns on</p> 

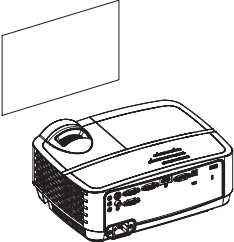
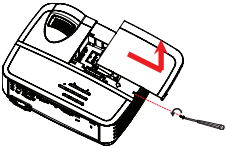
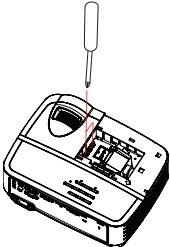
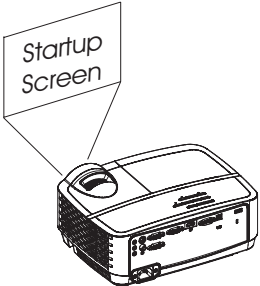
Problem	Solution	Result
<p data-bbox="48 101 531 152">“Replace lamp” message appears at startup, lamp won’t turn on</p> 	<p data-bbox="604 106 968 133">Lamp must be replaced (see page 46)</p>  <p data-bbox="887 156 991 179">lamp door</p>  <p data-bbox="666 439 791 462">replace lamp</p>	<p data-bbox="1182 95 1329 118">Lamp turns on</p>  <p data-bbox="1308 175 1395 238">Startup Screen</p>

Still need assistance?

If you need assistance, visit our website at www.infocus.com/support or call us. See the Quick Start Guide for support contact information.

This product is backed by a limited warranty. An extended warranty plan may be purchased from your dealer. When sending the projector in for repair, we recommend shipping the unit in its original packing material, or having a professional packaging company pack the unit. Please insure your shipment for its full value.

Using the remote control

The remote uses two (2) AAA batteries (not provided). They are easily installed by removing the cover from the remote's back, aligning the + and - ends of the batteries, sliding them into place, and then replacing the cover.

Caution:

- When replacing the remote batteries, be aware that using batteries other than AAA batteries may risk severe damage to the remote. When disposing of the batteries, be sure to do so in an environmentally proper manner.
- If the remote control gets wet, wipe it dry immediately.
- Avoid excessive heat and humidity.
- Ensure the batteries' polarity (+/-) is aligned correctly.
- Do not mix new and old batteries together, or mix different types of batteries together.
- Replace the batteries as soon as they run out.
- Remove batteries from the remote control when storing or not in use for a prolonged period.

To operate, point the remote at the front of the projector (not at the computer). The range of optimum operation is about 15 feet (4.5m).

Press the remote's **Power** button to turn the projector on and off (see page 11 for shutdown info).

Press the remote's **Menu** button to open the projector's menu system. Use the arrow buttons to navigate, and the **Select** button to select features and adjust values in the menus. See page 24 for more info on the menus.

The remote also has:

- **Volume** buttons adjust the sound.
- **Custom** button that can be assigned to a special function, like Blank Screen or Freeze (see page 27).
- **Source** button brings up a menu of all possible sources allowing the user to switch the active source.
- **Blank** button to blank the screen.
- **Presets** button to select stored settings (see page 25).
- **Mute** button to silence the audio.

- **Auto Image** button to resynch the projector to the source.
- **Resize** button to switch among aspect ratios (see page 25).
- **Help** button to get help with connecting sources and improving the picture.
- **ESC** button to go back to previous OSD menu.
- **PC** button to cycle through the Computer sources.
- **Video** button to cycle through Composite/S-Video/HDMI input sources.
- **Keystone** buttons adjust the squareness of the image
- **Magnify** buttons magnify and reduce the projected picture size.
- **Freeze** button to pause the projected image.
- **Overscan** button remove noise around the video image.
- **AV Mute** button blanks the projected image and mutes audio.

Troubleshooting the remote

- Make sure the batteries are installed in the proper orientation and are not dead.
- Make sure you're pointing the remote at the projector or the screen, not the computer, and are within the remote range of 15 feet (4.5m). For best results, point the remote at the projector.

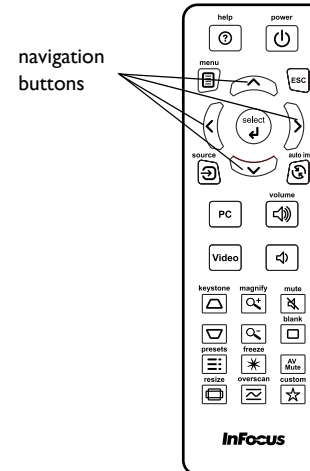

Using the audio

Using the projector's speakers

Connect the audio source to the **Audio 1/Audio 2** connectors to hear audio through the projector speakers.

Amplified speakers may also be connected to the projector using the Audio Out connector.

To adjust the volume, press the **Volume** buttons on the remote.

Troubleshooting Audio

If you aren't hearing the audio, check the following:

- Make sure the audio cable is connected to the **Audio 1/Audio 2** connector on the projector, and that the other end of the cable is connected to an Audio Out connector on the source (not a "line-in" or "microphone" connector).
- Make sure the volume is turned up enough. Press the **Volume** button on the remote.
- Make sure the correct source is active.
- Adjust the audio source.
- If playing a video, make sure the playback has not been paused.

connect audio cable

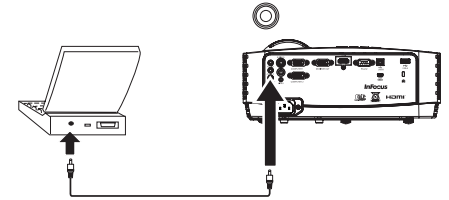

Using the keypad buttons

Most buttons are described in detail in other sections, but here is an overview of their functions:

Power—turns the projector on and off (page 8).

Right arrow - When the menu is displayed, the right arrow button navigates through the menu.

Up arrow/Keystone - When the menu is displayed, the up arrow button navigates through the menu. When the menu is not displayed, this button adjusts the squareness of the image (page 9).

Down arrow/Keystone - When the menu is displayed, the down arrow button navigates through the menu. When the menu is not displayed, this button adjusts the squareness of the image (page 9).

Left arrow - When the menu is displayed, the left arrow button navigates through the menu.

Enter - Activates the selected On-Screen Display (OSD) menu item.

Menu/Exit - Turns on the On-Screen Display (OSD) menu. Goes back to previous OSD menu, exits and saves menu settings.

Auto - Resynchronizes the projector to the source.

Blank - Displays a solid color or factory logo screen.

Source - Brings up a menu of available sources.

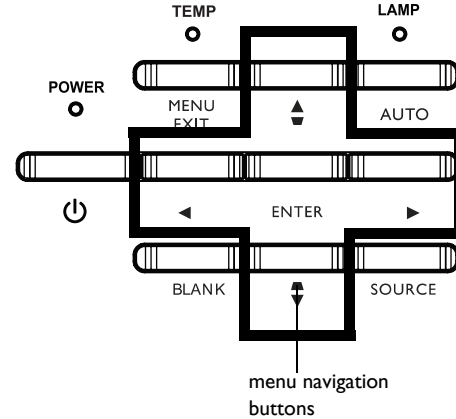

Optimizing computer images

After the projector is running and the image is on the screen, you can optimize the image using the onscreen menus. For general information on using the menus, see page 24.

- Select default image settings using a preset appropriate to your environment.
- Adjust the Keystone, Contrast, or Brightness (page 25).
- Change the Aspect Ratio. Choose the option that best fits your input source (page 25).
- Adjust the Color Temperature (page 26).
- Adjust the Phase, Tracking, or Horizontal or Vertical position (page 26).
- Once you have optimized the image for a particular source, you can save the settings using Presets. This allows you to quickly recall these settings later (page 25).

Presentation features

Several features are provided to make giving presentations easier. Here is an overview, details are found in the menu section.

- The Custom key allows you to assign various features to the button. The default effect is Source Info, which displays information about the projector and current source. See page 27 for details.
- The Search Screen option lets you change the appearance of the blank screen and start up screen (page 28).
- Auto Off Time is provided to automatically shut down the projector after several minutes. This helps preserve lamp life (page 28).
- When the projector is connected to the computer via USB Type B, the up and down arrows can be used as page up and page down controls.
- When the projector is connected to the computer via USB Type B, the projector will prevent the computer from going into screen saver mode during your presentation.

Optimizing video images

After your video device is connected properly and the image is on the screen, you can optimize the image using the onscreen menus. For general information on using the menus, see page 24.

- Adjust the Keystone, Contrast, Brightness, Color, or Tint (page 25).
- Change the Aspect Ratio. Choose the option that best fits your input source (page 25).
- Select a Sharpness setting (page 25).
- Adjust the Color Temperature. Select a listed warmth value (page 26).
- Turn on Overscan to remove noise on the edges of the image (page 26).

Customizing the projector

You can customize the projector for your specific setup and needs. See page 27 for details on these features.

- For rear projection, turn Rear Project on in the Advanced Menu > Setup > Image Setup... menu.
- For ceiling mounted projection, turn Ceiling Mount on in the Basic menu.
- Specify which source the projector checks first for active video during power-up.
- Specify the function of the Custom key on the remote.
- Turn the projector's display messages on and off.
- Turn on power saving features.
- Specify appearance of blank screen and startup screen.
- Specify the language viewed on the menus.
- Save settings for the active source as a preset.

Using the menus

- 1 To open the menus, press the **Menu** button on the keypad or remote. (The menus automatically close after 60 seconds if no buttons are pressed.) Use the arrow buttons to move up and down to review the menu options.
- 2 To enter a submenu, highlight the desired submenu and press > on the keypad or **Select** on remote.
- 3 To adjust a menu setting, highlight the desired menu option and press < or > to scroll through the available adjustments.
- 4 Press the **Menu** button to exit the menu system.

The menus are grouped by usage:

- The Basic Menu provides common adjustments.
- The Advanced Menu provides more complex adjustments.

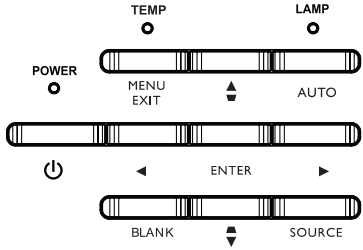

keypad navigation buttons

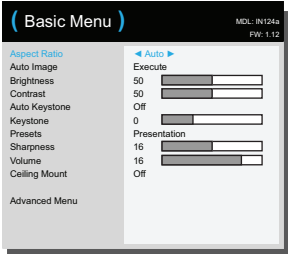

Basic Menu

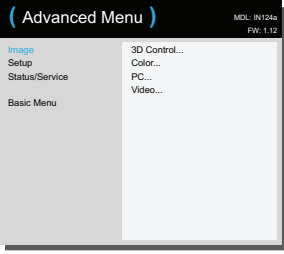

Advanced Menu

Basic Menu

To adjust the following settings, highlight the setting, use the right and left arrows to adjust the values.

Aspect Ratio: Aspect ratio is the ratio of the image width to image height. TV screens are usually 4:3. HDTV and most DVDs are 16:9.

Select Auto to have the projector choose the ratio. Choose Native to see the unmodified input with no resizing by the projector. Select 16:9 to watch enhanced widescreen DVDs.

Auto Image: resets the projector to the source.

Brightness: changes the intensity of the image.

Contrast: controls the degree of difference between the lightest and darkest parts of the picture and changes the amount of black and white in the image.

Auto Keystone: automatically corrects distorted images resulting from an angled projection.

Keystone: adjusts the image vertically and makes a squarer image. You can also adjust keystone from the keypad.

Presets: Presets are provided that optimize the projector for displaying computer presentations and video images under certain conditions. Note: Users can save their settings as a User Preset.

Sharpness: Changes the clarity of the edges of a video image. Select a sharpness setting.

Volume: increases or decreases the audio volume.

Ceiling Mount: turns the image upside down for ceiling-mounted projection.

Basic Menu

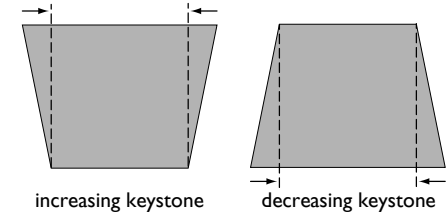
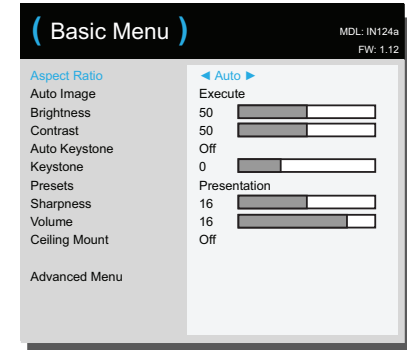

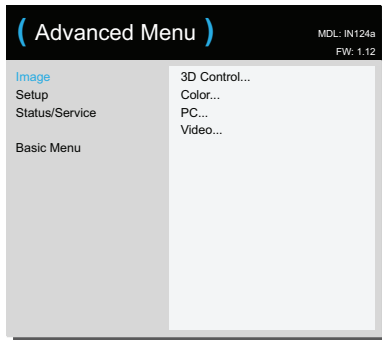

Advanced Menu

Image:

3D Control:

3D: allows you to enjoy 3D (stereoscopic) content. Your projector supports Auto, Top-Bottom, Frame Sequential, Frame Packing, Side-by-Side for controlling LCD shutter glasses. In addition to the projector, you will need a pair of 3D shutter glasses, 3D content, and 3D compatible source. Ensure the glasses you choose are consistent with the synchronization mode you will be using.

3D Sync Invert: If the image appears to flutter, look odd or if the image depth looks off or you experience eye strain, turn this feature on to see if the image improves.

Color

Color: adjusts a video image from black and white to fully saturated color. The color setting applies to video sources only.

Red/Green/Blue Gain: adjusts the gain of the red, green or blue channel of the image.

Red/Green/Blue Offset: adjusts the offset of the red, green or blue channel of the image.

Color Space: applies to computer and component video sources. It allows you to select a color space that has been specifically tuned for the input signal. When Auto is selected, the projector automatically determines the standard. To choose a different

setting, turn off Auto, then choose RGB for computer sources or choose either REC709 or REC601 for component video sources.

Color Temperature: changes the intensity of the colors. Select a listed relative warmth value.

Gamma: select the appropriate gamma from among Video, Film, Bright, and CRT.

Tint: adjusts the red-green color balance in the image of NTSC video images. The tint setting applies to NTSC video sources only.

White Intensity: increases the brightness of whites that are near 100%.

PC:

Force Wide: when this is off, the analog locking algorithms choose the standard mode resolution (4:3) as the preferred default resolution. When this is on, the analog locking algorithms choose wide mode resolution (16:10) as the preferred default resolution.

Phase: adjusts the horizontal phase of a computer source.

Prevent PC Screen Saver: prevents your computer from going into Screen Save mode. The projector must be connected to the PC via a USB cable for this feature to work.

Sync Threshold: (progressive signals only) If a hardware device, such as a DVD player, is not syncing properly with the projector, select this option to help it to sync when connected to the projector.

Tracking: adjusts the vertical scan of a computer source.

Horizontal/Vertical Position: adjusts the position of a computer source.

Video:

Detect Film: determines whether the original source of the input video was film (progressive) or video (interlaced).

Overscan: removes noise around the video image.

Set Black Level: analyzes the current input image and calculates an offset value which is then added to the analog to digital converter black level value. This ensures optimum black level for each analog source.

Setup:

Audio Setup...

Internal Speakers: turns the internal speaker on or off.

Computer 1: selects the audio input for Computer 1 signal.

Computer 2: selects the audio input for Computer 2 signal.

Video: selects the audio input for video source.

HDMI: select the audio input for HDMI signal.

Closed Captioning...

Closed Captions: controls closed captioning. If the source is NTSC and contains captions on the selected channel, then the projector will display caption text overlaid on the image. When Closed Captions is off and volume is muted, closed captioning will appear. Options are: Off, CCI and CC2.

Image Setup...

Digital Zoom: reduces the size of projector's display area. If the display area has been resized by this setting, it can be moved by changing the **Horz Shift** and **Vert Shift** settings.

Magnify Level: magnifies the image. If the image has been magnified by this setting, it can be moved by changing the **Horz Shift** and **Vert Shift** settings.

Ceiling Mount: turns the image upside down for ceiling-mounted projection.

Rear Project: reverses the image so you can project from behind a translucent screen.

Keypad/Remote Settings...

Blank Key: select what to display when the blank key on the remote is pressed: a solid color screen (blue, black or white), or the factory logo screen.

Custom Key: allows you to assign a different function to the Custom button, allowing you to quickly and easily use the effect. Highlight an effect and press ^ or v on the keypad or **Select** on remote to choose a different one.

- **Blank Screen:** displays a solid color or factory logo screen.
- **Mute:** turns off all sound.
- **Source:** brings up a menu of available sources.
- **Auto Image:** resets the projector to the source.

- **Freeze Screen:** pauses the projected image.
- **Source Info:** the default action. Shows the Source Info menu.
- **Projector Info:** shows the Projector Info menu.
- **Overscan:** removes noise around the image.
- **AV Mute:** enables or disables AV Mute function.
- **Closed Captions:** enables or disables Closed Captions.

Keypad: enables or locks the projector keypad.

Lamp...

Programmed Dimming: When enabled, Programmed Dimming enhances contrast ratios, lamp life and system noise performance. Lamp power will change continuously based on the brightness of the program content. Note: Image anomalies may be seen when image scenes change from dark to light (or light to dark). This is normal. Programmed Dimming works in conjunction with the lamp. If Lamp Low Power is enabled, Programmed Dimming is unavailable. Note: Programmed Dimming is off by default.

Lamp Low Power: toggles between on and off. Turn it on to lower the light output of the lamp. This also lowers the fan speed, making the projector quieter.

OSD Setup...

Language: allows you to select a language for the onscreen display.

Menu Position: allows you to change the position of the On Screen Display items.

Menu Transparency: allows you to change how much of the projected image behind the menu you can see. As the value increases, more of the image behind the menu is visible.

Show Messages: displays status messages (such as “Searching”) in the lower-left corner of the screen.

PIN Settings

PIN Protect: The PIN (personal identification number) feature allows you to password protect your projector. Once you enable the PIN feature, you must enter the PIN before you can project an image. Use the **Left/Right/Up/Down** arrows buttons on the remote or keypad to set a 4-button press sequence. If you enter an incorrect PIN 3 times in succession, the projector will automatically shut down. If you lose or forget your custom PIN, contact InFocus Technical Support.

To enter the PIN at projector startup:

Power up the projector. The “Enter PIN” dialog box appears after the startup screen. Enter the PIN. Use the **Left/Right/Up/Down** arrows buttons on the remote or keypad to enter the correct 4-button press sequence. See the description above for instructions.

To change the PIN:

Select “Change PIN...” in the Advanced Menu > Setup > PIN settings menu. Enter the existing PIN. Enter the new PIN.

Power

Power Saving Mode: When the Power Saving Mode is On and the projector is in standby (powered off but connected to AC power), external audio, network functions, and the Monitor Out function will not work.

AC Power On: When this feature is enabled, the projector automatically turns on when power is connected. This allows control of ceiling mounted projectors with a wall power switch.

Instant Power On: When this feature is enabled and it has been less than 1 minute since the projector was powered down, you can turn the projector back on immediately. When this feature is disabled, you will need to wait for the projector lamp to completely cool before restarting the projector.

Eco Blanking: When this feature is enabled and no video source is sensed, 70% of lamp power is saved and no image is shown. When the video source is again applied, the image is shown immediately.

Source

Auto Source: When this feature is On, the projector automatically finds the active source, checking the selected Power-up Source first. When this feature is Off, the projector defaults to the source selected in Power-up Source. To display another source, you must manually select one by pressing the **Source** button on the remote or keypad and selecting one from the displayed Source menu.

Power-up Source: determines which source the projector checks first for active video during power-up.

Search Screen: allows you to display a blank screen instead of the default screen at startup, and when no source is detected.

Timer

Auto Off Time: automatically turns the projector off after no signals are detected for a preset number of minutes. If an active signal is received before the projector powers down, the image will be displayed.

High Altitude Setting

High Altitude: We recommend you turn on the High Altitude Mode when your environment is between 5000' (1500m) and 10,000' (3000m) above sea level.

Network

Wireless LAN

SSID: Display the projector's SSID information.

IP Address: a read-only display of IP Address.

Subnet Mask: a read-only display of Subnet Mask.

Restart Network...: Restart network settings.

Status/Service:

Source Info: a read-only display of current source settings.

Projector Info: a read-only display of current projector settings and lamp hours.

Reset Lamp Hours...: resets the lamp hours used counter in the Projector Info menu to zero. Do this only after changing the lamp.

Factory Reset...: restores all settings to their factory default settings..

Service Code...: only used by authorized service personnel.

Controlling the projector through a WLAN environment

You can manage the projector from a computer using a web browser when the computer and the projector are properly connected to the same local area network.

To connect to the projector wirelessly, you need to plug an optional InFocus wireless dongle (p/n SP-WIFIUSB-2) to the USB Type A connector on the projector.

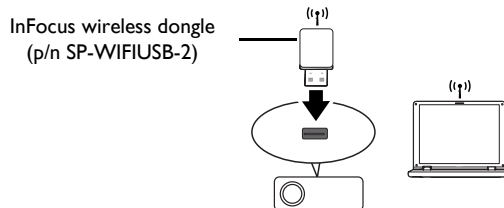

How to setup AP mode:

- 1 Select Type-A from source list.
- 2 Go to **Settings > WiFi**, select **AP Mode** and set it to **ON**. See page 42. AP mode is set to **ON** by default.
- 3 Select **WLAN** from source list. AP Info page displays.



How to setup client mode:

- 1 Select Type-A from source list.
- 2 Go to **Settings > WiFi**, select **Client Mode** and set it to **ON**. See page 42.
- 3 Choose the Wi-Fi network which the projector connect to from the Wi-Fi

network list, and press **Select/Enter**.

- 4 Press **Select/Enter** to display on-screen keyboard, enter the password from the on-screen keyboard, then press **Menu** to close the keyboard.

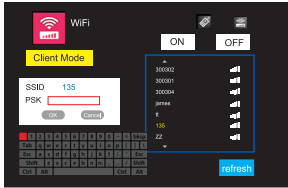

- 5 Highlight OK and press **Select/Enter** to wait for connecting successfully.
- 6 Select **WLAN** from the source list. Client Info page displays.

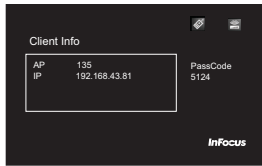

Web controlling the projector

Once you have the correct IP address for the projector and the projector is on or in standby mode, you can use any computer that is on the same local area network to control the projector.

- If you are using Microsoft Internet Explorer, make sure it is version 7.0 or higher.
- The screenshots in this manual are for reference only, and may differ depending on your browser.

- 1 Enter the IP address on the AP Info page in the address bar of your computer browser and press **Enter**.



- 2 The main page of the Network Control displays.

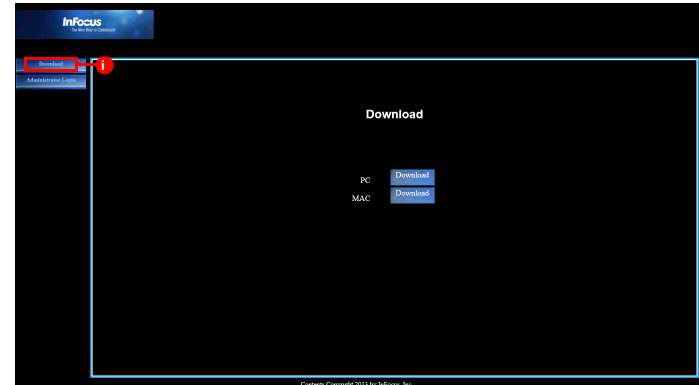

- i. To download EZ Display, click Download. See page 31 for details.

- To access the Admin page, enter the password. The default password is "0000".



- **Information:** Displays the status, wired LAN, and wireless LAN information.
- **Email Alert:** Allows you to setup the mail server and send system error messages to your network administrator.
- **Control Panel:** Provides some OSD menus such as Basic Menu, Image, Setup, Status/Service for adjusting the projected pictures. See page 24 for details.
- **Basic Menu:** Provides some common adjustments in Basic Menu.
- **Image:** Provides some common adjustments in Image settings under Advanced Menu.
- **Setup:** Provides some common adjustments in Setup settings under Advanced Menu.
- **Status Service:** Provides Reset Lamp Hours and Factory Reset settings.

Displaying images through EZ Display

Installation for Windows and Macintosh

EZ Display is an application which can run on the host PC. It helps connect your computer to an available network projector and transfer the desktop content to the network projector via local network connection.

- Access the projector Web page to download EZ Display, see page 30.
- Download the correct EZ Display for your computer type (MAC or PC).
- When the download is complete, install the software to your computer by clicking the exe file. Follow the on-screen instructions to complete the installation.
- Launch EZ Display and enter the passcode on the AP Info page.

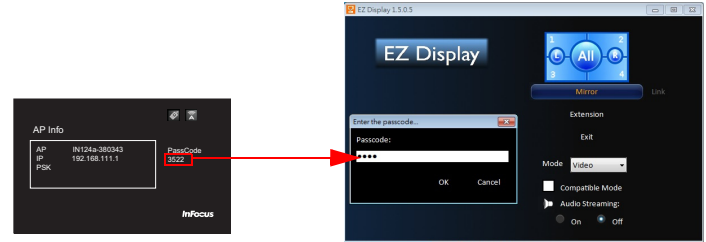

For more information about the applications EZ USB and EZ Display, review these manuals at www.infocus.com/support:

- EZ USB Display Manual(Win+Mac)
- EZ Display Manual-Mac
- EZ Display Manual-Win
- EZ Mobile Operation
- EZ Display - EZ Remote Manual-Android
- EZ Display - EZ Remote Manual-iOS

Using EZ Display



- i. **4 to 1 Display:** To display up to 4 computers simultaneously, click on the location you want to display to. If you only have 2 computers, choose L (left) or R (right). To display in full screen mode, click **All**. You can change the location at any time.
- ii. **Mirror/Extended Display:** To duplicate your computer display onto the projector, click **Mirror**. To extend your desktop display onto the projector, click **Extension**.
- iii. **Video/Graphic Display:** To display the best image quality, but with a slightly slower transmission speed, click **Video**. To display images faster, but with slightly less quality, click **Graphic**. Note: Transmission performance is determined by your network speed.
- iv. **Compatibility Mode:** Check the Compatibility mode box, if the projector is having trouble displaying video from any media players.
- v. **Audio Streaming:** To turn Audio Streaming on or off, click On or Off as appropriate.

Note: Supported functions vary per computer's operating system.

Projecting from Smartphones/Tablets

EZ Display is a special program to project your iOS or Android device display to a projector through a WiFi connection. You can remotely control the projector, decode document files, link to your dropbox account, surf the web, view photos, display a live camera feed and transfer files wirelessly. You can even annotate documents, webpages and photos and save them for sharing.

System Requirements

iOS

iOS	iOS 5.1 and above
Device	All iPhone model after iPhone 3GS All iPad model after iPad 2 All iPod touch after iPod touch 4th generation
Resolution support	iPhone: 480x320-1136x640 iPad: 1024x768-2048x1536
Storage	At least 20MB free space needed

Android

OS	Android ICS 4.0 and above
CPU	1 Ghz above
Memory	1 GB DDR above
Storage	At least 20MB free space needed

Installation for Android and iOS

Search for “EZ Display” and “EZ Remote” in Google Play or App Store, then download and install the applications. Before downloading, please make sure your device is supported.

Start up

- 1 Insert the optional USB WiFi Adapter (SP-WIFIUSB-2) into the USB Type A input.
- 2 Select the connection mode in the **Settings > WiFi** from Type-A source. See page 29 for details.

3 Select **WLAN** from source list. AP Info page displays.

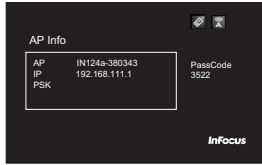

4 Establish WiFi connection with your source device first, and launch EZ Display/ EZ Remote app on your mobile device.



iOS screen



Android screen

EZ Remote

Launch EZ Remote. You will see the connected device shown on the device list. Click it to enable Remote control.

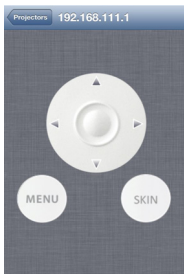

iOS screen



Android screen

*Skin button is reserved for future feature.

EZ Display

Launch EZ Display and it will scan for and list the device's IP address. When you click the device, a passcode is required. Enter the 4 digit number shown on your projector. After entering the correct passcode, EZ Display will display and allow you to select the different feature options.



iOS screen

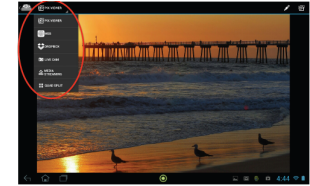

Android screen



EZ Display: Streaming Doc

To stream your documents, transfer the documents you want from the computer to your mobile device and disconnect your mobile device. Documents will be organized by their format type.

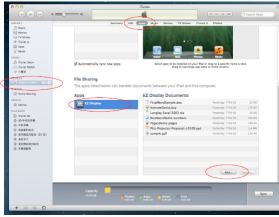

Select a file to display it wirelessly. Click the Sketch icon to begin drawing and annotating your file. Click Save when you are done editing.

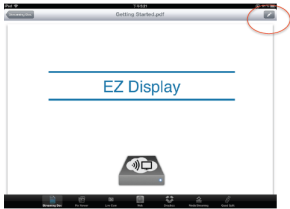

iOS screen

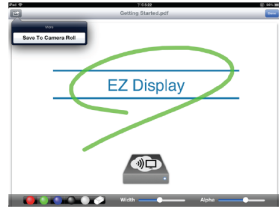

Android screen

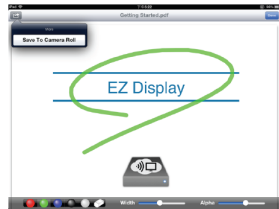

EZ Display: Pix Viewer

To display your photos, select **Photo Gallery** and select your photo. You can also draw on it with the Sketch feature.



iOS screen

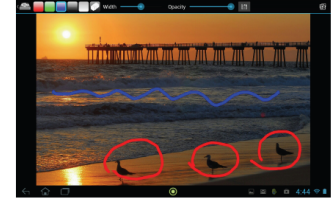

Android screen

EZ Display: Live Cam

Live Cam will project what your camera sees in real-time. You can adjust the image quality and switch between the front or rear view of the camera. When you pause the camera stream, you can enable Sketch and zoom in/out the current image. You can also save your camera stream as a camera roll.

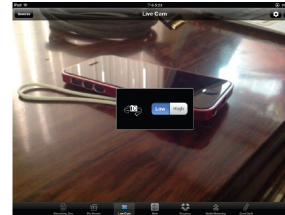

iOS screen

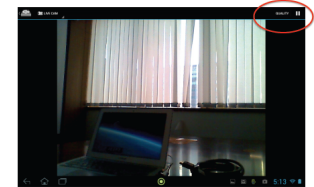

Android screen

EZ Display: Streaming Web

The web browser will be displayed over WiFi. The Sketch and Save functions are also supported. This feature requires a Client Mode internet connection. See page 29 for more details. Select Web browser, and enter the passcode on the Client Info page. The default home page is www.google.com

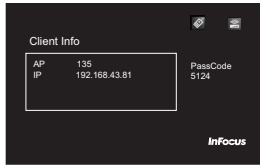

EZ Display: Dropbox

Once you have allowed EZ Display to access your Dropbox account, you will be able to log in using your Account ID and password, and choose the documents and photos you would like to display. This feature requires a Client Mode internet connection. See page 29 for more details.

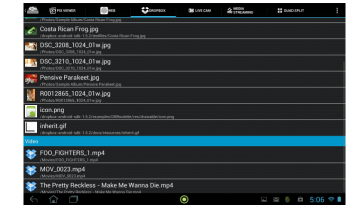
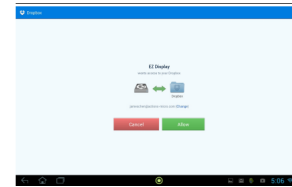
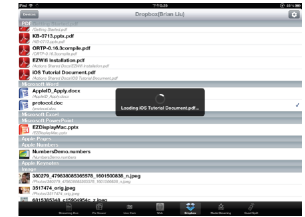

EZ Display: Quad Split Screen

EZ Display allows 4 different sources to be displayed in the same screen. Through Split Screen Control, you can decide where your current display should be placed.

NOTE:

- Up to 4 different devices can project in the same display
- Hybrid OS support: Windows, Mac OS, iOS, and Android
- Supports all web, sketch and other functions except EZ Stream.



iOS screen

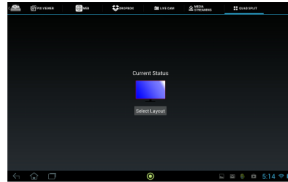

Android screen

EZ USB Display

The EZ Display software is an easy to use software application for Windows-based and Mac OS 10.7 and later operating systems which allows you to display PC content through the projector's USB connection. Both mirror and extended display are supported.

Features

- Full Screen Mirror Display and Extended Display
- USB2.0 High Speed Transfer
- OS support: Windows XP 32/64bit SP3 (Professional or above), Windows Vista 32/64bit SP2 (Home premium and above), Windows 7 32/64bit SP1 (Home premium and above) and Windows 8, Mac OS 10.7 and later

System Requirements

Windows OS:

CPU	Dual Core 2 GHz or higher (ATOM not supported)
Graphic card	Intel, nVIDIA or ATI graphic card with 64MB VRAM or above
Operating System	Windows XP SP3, Vista SP2, Windows 7 SP1, Windows 8
USB	USB 2.0 High Speed

NOTE: Audio is not supported on XP.

Mac OS:

CPU	Dual Core Intel Core i 1.4 GHz or higher (PowerPC not supported)
Graphic card	Intel, nVIDIA or ATI graphic card with 64MB VRAM or above
Operating System	Mac OS X 10.7 and above
Recommended Models	Mac Book series and iMac series after E/2011

Recommended System Configuration

Windows OS:

CPU	Dual Core Intel Core i5 2.4Ghz
Memory	DDR 4GB
Graphic card	256MB VRAM or above
Operating System	Windows XP SP3, Win 7 SP1 or Win 8
USB	USB 2.0 High Speed

Mac OS:

CPU	Dual Core Intel Core i5 2Ghz
Memory	DDR 4GB
Graphic card	256MB VRAM or above
Operating System	Mac OS X 10.8
Recommended Models	Mac Book series and iMac series after E/2011

For information about this, refer to the EZ USB Display Manual at www.infocus.com/support.

Displaying pictures with a USB storage device

When a USB source is inserted into the projector USB-A connector, press the Source key and use the arrow keys to highlight the USB icon.

Press the Select key on the remote (or the Enter key on the projector) to select the multimedia source. The Multimedia EZ Suite menu displays.

Use the arrow keys to navigate up and down, left and right. The right-hand menus change based on the left-hand menu selection.

To select a menu option, press the right-hand arrow.

To return to the previous EZ Suite menu (and ultimately the EZ Suite main menu), press the **Menu** or left arrow key.

Internal Memory

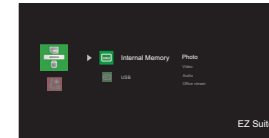

With a mini-B USB cable connected to your PC and the projector, you can load internal memory.

Photo mode

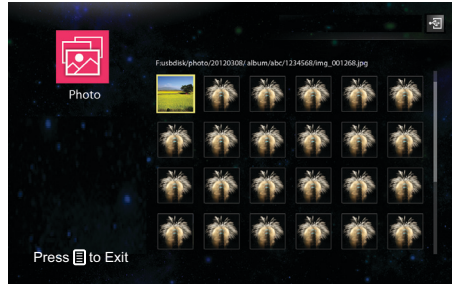

Folders and supported files are represented in thumbnail view.

Key	Action
Up	Scroll through the thumbnails
Down	
Left	
Right	
Select/Enter	Open a file
Menu	Exit thumbnail view and return to EZ Suite main menu

Displaying a picture

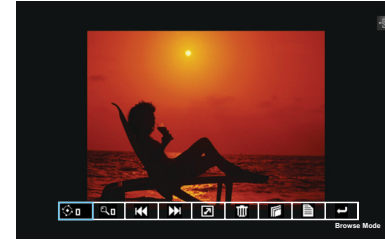

- To open/close the Photo View toolbar: press the **Menu** key.
- To navigate through the toolbar: press the arrow keys **^**/**<**/**>**.
- To return to thumbnail view: press the **Select/Enter** key.

Toolbar icon	Action
	Press v/Enter/Select to select picture rotation Toggle the Enter/Select /four arrow keys to rotate the picture counterclockwise, press Menu key to exit from it.
	Toggle Enter/Select to zoom in the picture by x0, x1, x2, x3, x4 in sequence, press Menu key to exit from it.
	Toggle v/Enter/Select to display the previous picture
	Toggle v/Enter/Select to display the next picture
	Press v/Enter/Select to start slideshow when Slideshow is On, press Menu key to stop the slideshow.
	Press v/Enter/Select to open the pop-up message screen, press Menu key to close it.
	Press v/Enter/Select to open the pop-up message screen, press Menu key to close it.
	Press v/Enter/Select to display the current file information
	Press v/Enter/Select to return to thumbnail view

Video mode

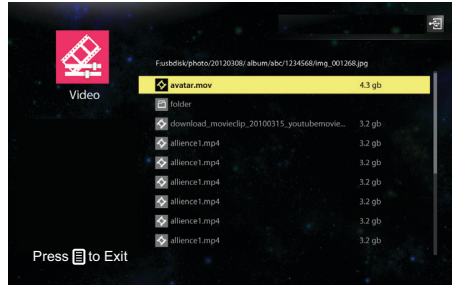
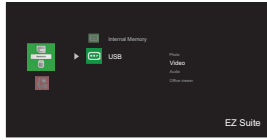

Video playlist is displayed on the screen

Key	Action
Up	Go to the previous video file
Down	Go to the next video file
Select/Enter	Play the video
Menu	Exit video playlist and return to EZ Suite main menu

When a video is playing

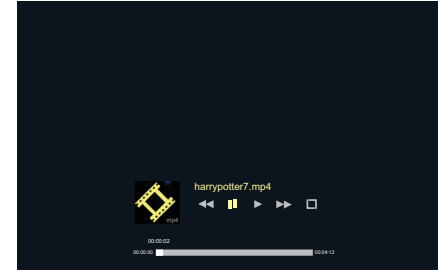

- To open the Video Viewer toolbar: press the **Menu** key.
- To return to video playlist: press the **Select/Enter** key when the toolbar is closed.

Toolbar icon	Action
▶	Press Enter to pause while playing
	Press Enter to play when paused
◀◀	Fast backward by x1, x2, x4, x8
▶▶	Fast forward by x1, x2, x4, x8
□ / ☒	Repeat mode is set in Settings > Video menu. See page 42

Audio mode

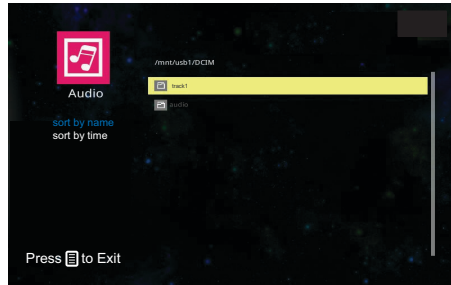
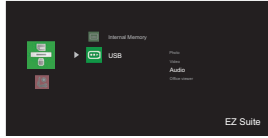

The Audio playlist is displayed on the screen.

Key	Action
Up	Go to the previous audio file
Down	Go to the next audio file
Left	Display the sort type
Select/Enter	Play the audio file
Menu	Exit audio playlist and return to EZ Suite main menu

When audio is playing

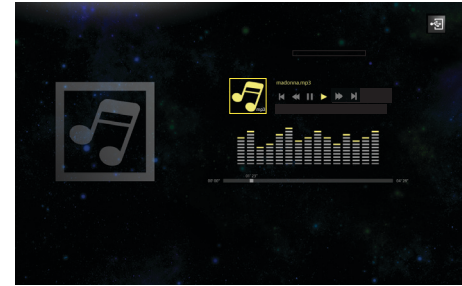

- To return to audio playlist: press the **Menu** key.

Toolbar icon	Action
⏮	Go to the previous audio file
⏪	Fast rewind
⏸	Pause
▶	Play
⏩	Fast forward
⏭	Go to the next audio file

Office viewer mode

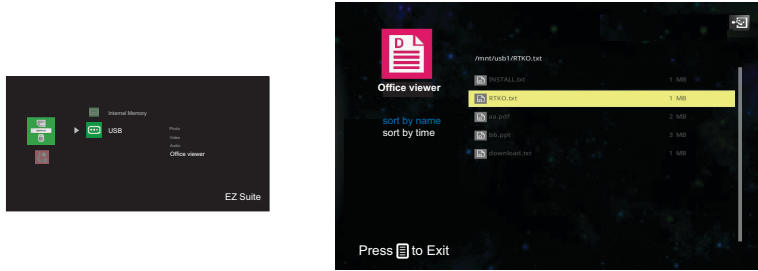

The file list is displayed on the screen.

Key	Action
Up	Go to the previous file
Down	Go to the next file
Left	Display the sort type
Select/Enter	Open a file
Menu	Exit file list and return to EZ Suite main screen

When an Office file is displaying

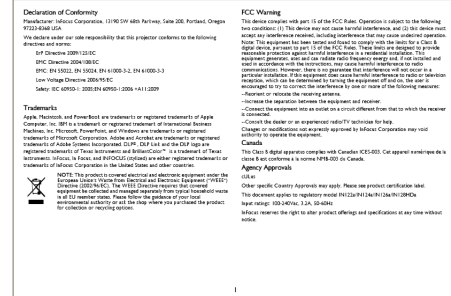

- To go to the next page: press the down arrow key.
- To go to the previous page: press the up arrow key.
- To scroll up: press the left arrow key.
- To scroll down: press the right arrow key.
- Or press the **Menu** key to open/close the Office Viewer toolbar. Use the right or left arrow key to highlight the desired function. Then press the **Select/Enter** key.

Fit to Screen/Fit to Width/Fit to Height

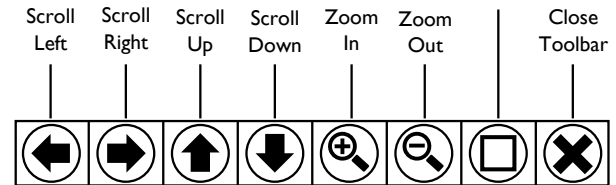

- To return to the filelist: close the toolbar first, and press **Select/Enter** key.

Note: The file name displays in the upper left corner of the Office Viewer toolbar. The current page number and number of pages appears on the upper right corner. The amount of magnification displays on the lower right corner.

Settings



- Press the **Select/Enter** to enter the selected item. Press the **Menu** key to exit.

System	Description
Version	Displays current EZ Media firmware version
Language	Sets EZ Media on-screen display language
Update	Update EZ Suite software by USB Key
UsbSwitch	Connects PC to access to internal memory

Photo	Description
Display Ratio	Sets the display (aspect) ratio
Slideshow	Enables slide show mode
Slideshow Duration	Sets the time interval each image displays

Video	Description
Display Ratio	Sets the display (aspect) ratio.
Repeat Mode	Sets repeat mode

Audio	Description
Repeat Mode	Sets repeat mode

WiFi	Description
AP Mode	Sets AP mode on/off. AP mode is set to ON by default. See page 29 for more details.
Client Mode	Sets Client mode on/off. See page 29 for more details.
EZ Remote	Sets EZ remote on/off. See page 33 for more details.

* WiFi only works when the InFocus wireless dongle (p/n SP-WIFIUSB-2) is connected.

Supported file formats

• Images

Image Format	Profile	Color Space	Size Limitation
JPEG	Baseline	YUV400	No limit
		YUV420	No limit
		YUV422	No limit
		YUV440	No limit
		YUV444	No limit
	Progressive	YUV400	Width <= 10240 & height <= 6400
		YUV420	
		YUV422	
		YUV440	
BMP	No limit	No limit	No limit

• Audio

Audio Format	Sample rate (KHz)	Bit Rate (Kbps)
OGG	8-48	64-320
ADPCM-WAV	8-48	32-384
PCM-WAV	8-48	128-1536
AAC	8-48	8-256

• Voice Record

File Format	Audio Format	Sample rate (KHz)	Bit Rate (Kbps)
.wav	IMA-ADPCM	8	32
		16	64
		24	192
		48	384

• Video

File Extensions	Audio/Video	Codec	Profile/ Level Support	Explanation
.avi .divx .mkv	Video	MJPEG	No limitations	
		H.264/AVC	Up to High Profile , Levels 1- 4.1 (1080P 30fps 20Mbps)	Only supports 1-3 reference frames.
		XVID	Up to Advance Simple profile (1080P 30fps 20Mbps)	
		MPEG2	Main profile, Low and Main Levels (1080P 30fps 20Mbps)	
		MPEG4	Advanced Simple Profile (frame picture) , Levels 0-5 (1080P 30fps 20Mbps)	
		.ts	Video	MPEG2
H.264/AVC	Up to High Profile , Levels 1- 4.1 (1080P 30fps 20Mbps)			Only supports 1-3 reference frames.
.dat .vob .mpg .mpeg	Video	MPEG1	Main profile, Low and Main Levels (1080P 30fps 20Mbps)	D-frames used for fast previews are not supported.
		MPEG2	Main profile, Low and Main Levels (1080P 30fps 20Mbps)	
	Audio	MPEG-I Layer I, II		
MPEG-I Layer III (mp3)				
.mov .mp4	Video	MPEG4	Advanced Simple Profile (frame picture) , Levels 0-5 (1080P 30fps 20Mbps)	
		H.264/AVC	Up to High Profile , Levels 1- 4.1 (1080P 30fps 20Mbps)	Only supports 1-3 reference frames.

- Subtitle

Format	Font	Subtitle Size
Standard SRT	UTF-8 / UTF-16	4bits up to 448x200 2bits up to 896x200

Note: Mixed subtitle codes are NOT supported.

- Office Viewer

File Format	Support Version	Pages/Lines Limitation	Size Limitation	Comment
Adobe PDF	PDF 1.0	Up to 1000 pages (One File)	Up to 75MB	-
	PDF 1.1			
	PDF 1.2			
	PDF 1.3			
	PDF 1.4			
MS Word	British Word 95.	Because Office Viewer does not load all pages of a Word file simultaneously, there are no obvious page or line limitations.	Up to 100MB	Simplified Chinese bold text is not supported.
	Word 97, 2000, 2002, 2003.			
	Word 2007(.docx), 2010(.docx)			
MS Excel	British Excel 5, 95.	Maximum number of rows: 595	Up to 15MB	Password-protected documents are not supported.
	Excel 97, 2000, 2002, 2003.	Maximum number of columns: 256		
	Excel 2007(.xlsx), 2010(.xlsx).	Maximum number of sheets: 100		
	Office XP Excel.	All of the three above limitations apply.		

Maintenance

Cleaning the lens

- 1 Apply a non-abrasive camera lens cleaner to a soft, dry cloth.
 - Projector must be off and the lens must be at room temperature.
 - Avoid using an excessive amount of cleaner, and don't apply the cleaner directly to the lens. Abrasive cleaners, solvents or other harsh chemicals might scratch the lens.
- 2 Lightly wipe the cleaning cloth over the lens in a circular motion.

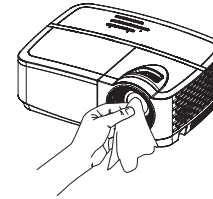

WARNINGS:

- Turn the projector off and unplug power cord before cleaning any part of the projector.
- Do not touch or block the projector lens with any objects as this can damage the projector lens. Scratches, gouges and other lens damage are not covered by the product warranty.
- Do not open any cover on the projector, except the lamp cover.
- Do not attempt to service this product yourself as opening and removing covers may expose you to dangerous voltage and other hazards. Refer all servicing to qualified service personnel.

Using the security lock

The projector has a security lock for use with a Cable Lock System. Refer to the information that came with the lock for instructions on how to use it.

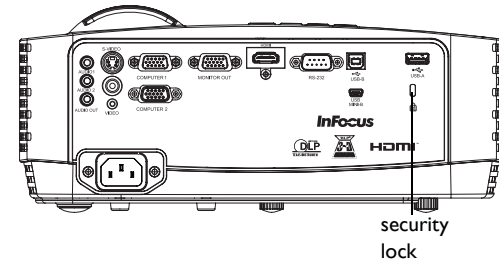

Replacing the projection lamp

The Lamp Hours timer in the Projector Info menu counts the number of hours the lamp has been in use.

- **NOTE:** Be sure to use the InFocus lamp module designed for this projector. You can order new lamps from www.infocus.com (in select areas), your retailer or your dealer. **Only genuine InFocus lamps are tested for use in this projector.** Use of non InFocus lamps may cause electrical shock and fire, and may void the projector warranty. InFocus is not liable for the performance, safety or certification of any other lamps.

WARNINGS:

- The projector uses a high-pressure mercury glass lamp. The lamp may fail prematurely, or it may rupture with a popping sound if jolted, scratched, or handled while hot. The risk of lamp failure or rupture also increases as the lamp age increases; please replace the lamp when you see the “Replace Lamp” message.
- To avoid burns, allow the projector to cool for at least 60 minutes before you replace the lamp.
- Do not touch or block the projector lens with any objects as this can damage the projector lens. Scratches, gouges and other lens damage are not covered by the product warranty.
- Unplug the power cord before replacing the lamp.
- Do not drop the lamp module. The glass may shatter and cause injury.
- Do not touch the glass surface of the lamp module. Fingerprints can obscure projection sharpness and may cause the glass to shatter.
- Be extremely careful when removing the lamp housing. In the unlikely event that the lamp ruptures, small glass fragments may be generated. The lamp module is designed to contain most of these fragments, but use caution when removing it.
- Before replacing a ruptured lamp, clean the lamp compartment and dispose of cleaning materials. Wash hands after lamp replacement.
- When replacing the lamp while the projector is ceiling-mounted, wear protective eyewear to prevent eye injury.

Hg – Lamp contains mercury. Manage in accordance with local disposal laws. See www.lamprecycle.org.

- 1 Turn off the projector and unplug the power cord.
- 2 Wait 60 minutes to allow the projector to cool thoroughly.
- 3 Remove the lamp door, located on top of the projector, by removing the screw on the side of the lamp door, sliding the door forward, and lifting the lamp door off.
- 4 Loosen the captive screws that attach the lamp housing to the projector.
NOTE: If the projector is installed on a ceiling mount, be careful not to drop the lamp module once the captive screws are loosened.
- 5 Carefully lift the lamp straight up, off of the alignment pins; being careful not to pinch the lamp connector. Dispose of the lamp in an environmentally proper manner.
- 6 Install the new lamp module, aligning the pins properly. Be careful not to pinch the lamp connector.
- 7 Tighten the screws. (**NOTE:** If the pins have not been aligned properly, the screws will not tighten securely.)
- 8 Replace the lamp door by (a) aligning the hinges, (b) putting the lamp door down and (c) locking it back into place.
- 9 Replace the lamp door screw and tighten securely.
- 10 Plug in the power cord and press the Power button to turn the projector back on.
- 11 To reset the lamp hour timer, navigate to the **Advanced Menu > Status/Service** menu and select **Reset Lamp Hours....**

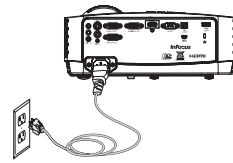

turn off and unplug
projector

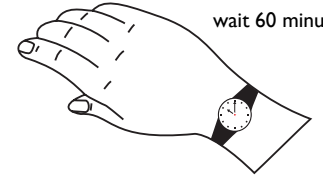

wait 60 minutes

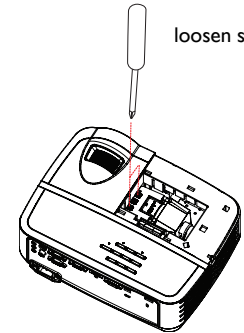
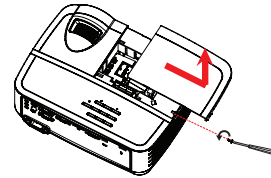

loosen screws

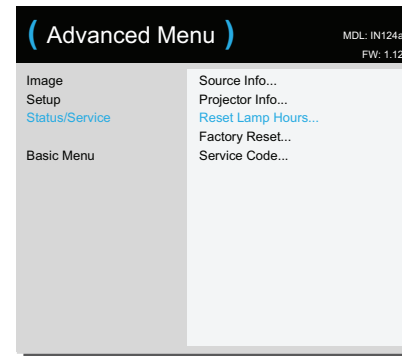

Numerics

3D Sync Invert 26

A

AC Power On 28

AP Mode 29, 42

Aspect Ratio 25

Audio 1/Audio 2 7

Auto Image 25

Auto Keystone 25

Auto Off Time 29

Auto Source 28

AV Mute 27

B

Blank Key 27

Blank Screen 27

Brightness 25

C

Cable box 10

Ceiling Mount 25, 27

Client Mode 29, 42

Closed Captions 27

Color Space 26

Computer 1 27

Computer 1/Computer 2 7

Computer 2 27

Connecting

 Video device 10

Connecting a video device 10

Contacting InFocus 18

Contrast 25

Crestron RoomView 31

Customer service contact information 18

D

Detect Film 26

Digital Zoom 27

E

Eco Blanking 28

EZ Display 30

EZ Remote 42

F

Factory Reset 29

Focus 9

Force wide 26

Freeze Screen 27

G

Gamma 26

H

HDMI 27

HDTV 25

High Altitude Setting 29

Horizontal Position 26

Horz Shift 27

I

Instant Power On 28

Internal Speaker 27

IP Address 29

K

Keypad 27

Keypad buttons 21

Keystone 25

L

Lamp Low Power 28

M

Magnify Level 27

Menu Transparency 28

menu usage 24

Mute 27

N

Network 29

O

only 26

Overscan 26, 27

P

Phase 26

PIN Protect 28

Power connector 7

Power cord 7

Power Saving Mode 28

Prevent PC Screen Saver 26

Programmed Dimming 28

Projector

 Connecting video devices 10

 Keypad buttons 21

 Menus 24

 Positioning 6

 Setting up 6

 Troubleshooting problems 11

Projector Info 27, 29

R

Rear Project 27

Red/Green/Blue Gain 26

Red/Green/Blue Offset 26

remote control 19

Resetting the projector 29

Restart Network... 29

S

Screen Aspect 10

Search Screen 28

Service 29

Set Black Level... 26

Sharpness 25

Show Messages 28

Source 27

Source Info 27, 29

SSID 29

Subnet Mask 29

Sync Threshold 26

T

Tint 26

Tracking 26

Troubleshooting 11

TV tuner 10

U

USB 5

USB MINI-B 7

V

Vert Shift 27

Vertical Position 26

Volume 25

Volume button 20

W

Warranty 18

WiFi 29, 42

Wireless connection 29

Wireless LAN 29

WLAN 29

Z

zoom 9